

**MP KOVANIA®**

KOVANIA NA DVERE, STAVBY A NÁBYTOK

**2022**

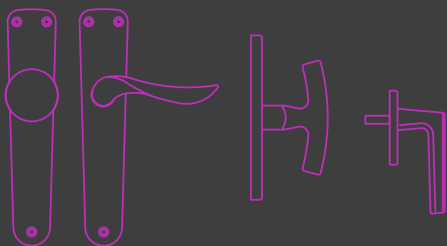

**MP**

**ALUMINIUM LINE**  
HLINÍKOVÉ KĽUČKY

**MP KOVANIA<sup>®</sup>**

KOVANIA NA DVERE, STAVBY A NÁBYTKO



Vážení zákazníci,

sme MP KOVANIA s.r.o., firma so slovenským kapitálom založená v roku 2002. Od tohto obdobia pôsobíme v oblasti dverných kovaní a doplnkov na celom území Slovenskej republiky a od roku 2008 aj na území Českej republiky. Prevádzkujeme veľkoobchodný a maloobchodný predaj so sieťou maloobchodných partnerov na celom území SR a ČR. V tejto oblasti si dlhodobo budujeme meno kvalitného a spoľahlivého partnera. Vo svojej činnosti vsádzame na stabilitu, spoľahlivosť v poskytovaní produktov a služieb, na kvalitnú a ochotnú predajnú i popredajnú starostlivosť.

V tomto katalógu predstavujeme hliníkový sortiment, pričom dôraz sme kládli na kvalitu, dlhoročnú funkčnosť produktov a priaznivé ceny.

Tím MP KOVANIA

## POMOCNÉ PRAVÍTKO

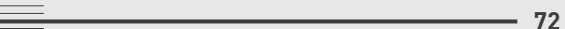

Typ otvoru a rozteč (vzdialenosť medzi osou kľučky a osou kľúča) sú vyrábané na objednávku podľa typu zámku.

Štandardná rozteč je 72 alebo 90 mm. Na objednávku je možné vyraziť rozteč 85, 88, 92 alebo 96 mm.

Uvedená informácia platí len pre štítové kovania. Pri rozetovom kovaní sa neurčuje rozteč.

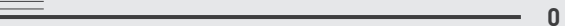

Odmerajte vzdialenosť medzi osou kľučky a osou kľúča (rozteč).

Štandardné rozmery sú zvýraznené hrubými čiarami.

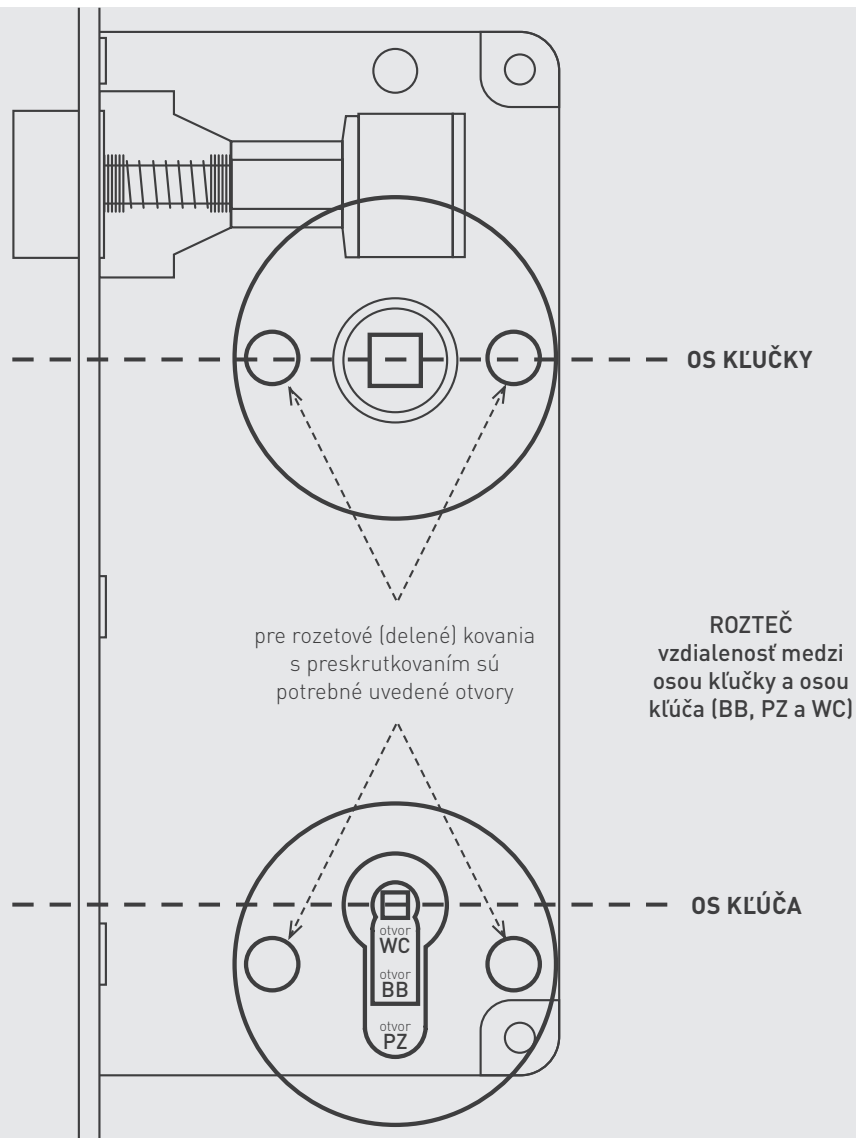

# NIEKOĽKO RÁD PRED ZAKÚPENÍM KĽUČIEK

## ŠTÍTOVÉ KĽUČKY

Pri objednávaní štítových kľučiek je potrebné vedieť vzdialenosť medzi osou kľučky a osou kľúča (rozteč). Štandardná vzdialenosť je 72 alebo 90 mm. Pre presné odmeranie vzdialenosti (rozteče) slúži pomocné pravítko, zobrazené na predchádzajúcej strane katalógu.

UPOZORNENIE: Nakoľko otvory do štítových kľučiek sú vyrábané na objednávku, je nevyhnutné pri objednávaní uviesť správnu rozteč a typ otvorov, v opačnom prípade výmena kľučiek nemusí byť samozrejmosťou.

## TYPY OTVOROV



### Skratka BB

označuje otvor pre interiérový kľúč (dózciký)



### Skratka PZ

označuje otvor pre cylindrickú vložku (fabku)



### Skratka WC

označuje WC sadu s kľúčom (k WC sade je potrebný zámok so spodným otvorom na štvorhran s rozmerom 6 x 6 mm)

## GULE

Pri kľučkách s guľou je potrebné uviesť, či ide o kľučku pravú (označujeme Re) alebo ľavú (označujeme Li). Štandardne je prevedenie guľa - kľučka dodávaná s guľou pevnou.

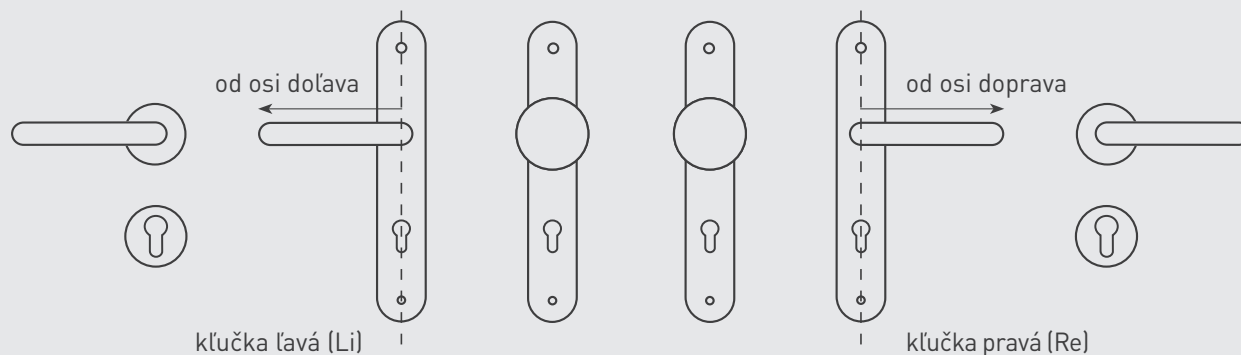

## POVRCHOVÉ ÚPRAVY

Sortiment v tomto katalógu je vyrobený z hliníka. Výrobky sú ošetrené kvalitnými povrchovými úpravami, napriek tomu nie každá povrchová úprava je vhodná do každého prostredia. Z hľadiska odolnosti povrchovej úpravy a frekvencie používania kovania sú všetky produkty označené symbolmi:



**nízka záťaž** – vhodné do interiérov s nízkou frekvenciou pohybu ľudí, napr. byty, rodinné domy a pod.



**stredná záťaž** – vhodné do interiérov so zvýšenou frekvenciou pohybu ľudí, napr. ubytovne, penzióny, hotely, kancelárie a pod.



**vysoká záťaž** – vhodné do interiérov s vysokou frekvenciou pohybu ľudí, napr. administratívne priestory, nemocnice, predajne, čerpacie stanice, nákupné centrá a pod.. Taktiež do exteriérov a v niektorých prípadoch aj do prostredia so zvýšenou vlhkosťou.



**vhodné do exteriérov** - povrchové úpravy odolné voči poveternostným vplyvom (slnko, voda, mráz)



B - BIELA



AS - ANTIK SIVÁ



NIM - NIKEL MATNÝ (F8)



S - STRIEBORNÁ



N - NIKLOVÁ



H - HNEDÁ



CP - CHRÓM PERLA

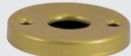

Z - ZLATÁ



HS - HNEDOSIVÁ



STM - STRIEBORNÁ  
MATNÁ (F1)



BRM - BRONZ MATNÝ (F4)



Č - ČIERNA



NP - NIKEL PERLA

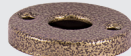

AH - ANTIK HNEDÁ



**Upozorenie:** Povrchové úpravy skutočných produktov nemusia byť totožné s grafikou uvedenou v katalógu.

## AKO SPRÁVNE OBJEDNÁVAŤ

Pre rýchle vybavenie objednávky je dôležité uviesť nižšie uvedené parametre, špecifické pre štítové a rozetové kľučky.

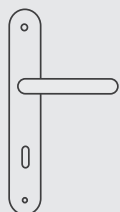

### ŠTÍTOVÉ KĽUČKY

- **NÁZOV MODELU** - napr. KE - LAURA
- **POVRCH** - napr. S, B, N, Z, AH, H, AS
- **TYP OTVORU** - napr. BB, PZ alebo WC
- **ROZTEČ** - napr. 72 alebo 90 mm
- **PREVEDENIE** - kľučka/kľučka alebo guľa/kľučka
- **ORIENTÁCIA KĽUČKY** - v prípade guľa/kľučka uviesť, či je kľučka ľavá Li alebo pravá Re
- **POČET KUSOV**

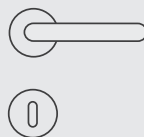

### ROZETOVÉ KĽUČKY (DELENÉ)

- **NÁZOV MODELU** - napr. KE - LAURA - R
- **POVRCH** - napr. S, B, N, Z, AH, H, AS
- **TYP OTVORU** - napr. BB, PZ alebo WC
- **PREVEDENIE** - kľučka/kľučka alebo guľa/kľučka
- **ORIENTÁCIA KĽUČKY** - v prípade guľa/kľučka uviesť, či je kľučka ľavá Li alebo pravá Re
- **POČET KUSOV**

## VYSVETLIVKY



obsahuje/ neobsahuje vratný mechanizmus kľučky - pružinu



predĺžená záruka 3 / 5 rokov



plastová rozeta



univerzálna montáž pravo-ľavé prevedenie



súčasťou balenia sú samorezné skrutky 3 x 20 mm v príslušnom počte ku kovaniu



možnosť doobjednať skrutky na preskrutkovanie cez dvere



súčasťou balenia je sada skrutiek na preskrutkovanie cez dvere



možné montovať aj jednostranne



rozteč - vzdialenosť medzi osou kľučky a osou kľúča 72 alebo 90 mm



rozteč - vzdialenosť medzi osou kľučky a osou kľúča 90 alebo 92 mm



rozteč - vzdialenosť medzi osou kľučky a osou kľúča 72, 90 alebo 92 mm



vhodné do exteriérov - povrchové úpravy odolné voči poveternostným vplyvom

## MONTÁŽ

Montáž je veľmi dôležitou súčasťou funkčnosti výrobku. Je potrebné klásť zvýšený dôraz na presné zameranie a vrtanie otvorov. Pri montáži je potrebné používať montážne návody, ktoré sú súčasťou balenia kľučiek, dostupné na webovej stránke, prípadne u predajcu. Je nevyhnutné používať diely, ktoré sú súčasťou balenia produktu. Je neprípustné upravovať kovanie pred a počas montáže.

Pred inštaláciou kľučky je potrebné premazať mechaniku kovania univerzálnym mazivom, napr. PECOL P230.

## OŠETROVANIE

Po inštalácii je vhodné raz ročne premazať mechaniku kovania. Na čistenie a ošetrovanie sa neodporúča používať agresívne chemikálie ani čistiace prostriedky. Kovanie je potrebné čistiť len mäkkou vlhkou handričkou.

Pri vydávaní neštandardných (písklavých) zvukov alebo pri zasekávaní mechaniky sa odporúča použiť univerzálne mazivo PECOL P230 - polosyntetický sprej, ktorý slúži na mazanie rôznych mechanických pohyblivých častí, poskytuje ochranu proti korózii, je odolný voči vode, slanému a kyslému prostrediu.



## BALENIE TOVARU

Balenie obsahuje dverné kovanie, návod na montáž, potrebné skrutky, imbusové kľúče, prípadne šablónu na montáž kovania.

Každý produkt je zabalený do ochranného obalu, ktorým je chránený voči poškodeniu pri manipulácii, resp. preprave.

## ZÁRUKA

Štandardne sa na produkty vzťahuje záruka 2 roky od dátumu predaja na pokladničnom doklade. Na vybrané produkty v tomto katalógu je poskytovaná predĺžená záruka 3 až 5 rokov.

Záruka sa nevzťahuje na poškodenie výrobku nesprávnym ošetrovaním, na opotrebovanie výrobku používaním, prípadne mechanickým poškodením (napr.

kľúčmi, prstienkami a pod.). Záruka sa tiež nevzťahuje na výrobky, ktoré boli po zakúpení dodatočne upravované zákazníkom alebo jeho montážnikom. Rovnako sa nevzťahuje na výrobky znehodnotené nekvalitnou montážou, nesprávnou manipuláciou alebo vlastnou prepravou. Takisto na umiestnenie výrobku do nevhodného prostredia – pozrite str. 6 „Povrchové úpravy“.

## GARANCIA KVALITY

Pri dodržiavaní vyššie uvedených pokynov a upozornení (vhodný výber kľučky podľa záťaže) je garantovaná dlhodobá životnosť výrobkov.

## VÝMENA TOVARU

Pri zistení závady alebo iného nedostatku, z ktorého vyplýva nárok na výmenu alebo reklamáciu je potrebné jednotlivé diely kovania zabaliť tak, aby nedošlo k ich ďalšiemu poškodeniu. V opačnom prípade poškodené diely nebudú vymenené.

## CENY

Ceny v katalógu sú platné od **01. 07. 2022**. Sú uvedené za kompletný výrobok, v prípade kľučiek za pár bez DPH v € alebo s DPH v €.

Prepravné podmienky pre obchodných partnerov v rámci SR:

Pri odbere tovaru **na faktúru** v hodnote nižšej ako 80,00 € bez DPH po zľave bude k cene tovaru pripočítané prepravné vo výške **4,50 € bez DPH**.

Pri odbere tovaru **na dobierku** v hodnote nižšej ako 80,00 € bez DPH po zľave bude k cene tovaru pripočítané prepravné vo výške **5,90 € bez DPH**.

Pri odbere tovaru v hodnote nad **80,00 € bez DPH** po zľave je prepravné **ZADARMO!**

Prepravné mimo SR a za nadrozmerné zásielky je stanovené individuálne.

Z dôvodu nestability cien materiálov na svetovom trhu si vyhradujeme právo na úpravu cien bez predošlého upozornenia. Aktualizácie cien a sortimentu sú zverejnené na: **[www.mp-kovania.sk/katalogy](http://www.mp-kovania.sk/katalogy)**.







S STRIEBORNÁ

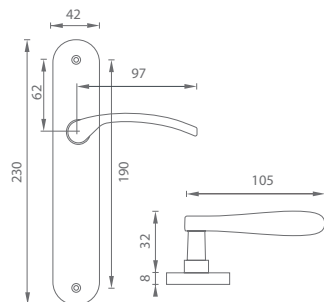

B BIELA



N NIKLOVÁ



Z ZLATÁ



AH ANTIK HNEDÁ







H HNEDÁ



AS ANTIK SIVÁ

## KE - LAURA

	Cena za set v €	S, B, Z, AH, H, AS		N	
		bez DPH	s DPH	bez DPH	s DPH
kl./kl. s BB otvorom pre kľúč		6,00	<b>7,20</b>	8,00	<b>9,60</b>
kl./kl. s PZ otvorom pre vložku		6,00	<b>7,20</b>	8,00	<b>9,60</b>
kl./kl. s WC kľúčom		7,00	<b>8,40</b>	9,00	<b>10,80</b>
guľa/kl. s PZ otvorom pre vložku		7,00	<b>8,40</b>	9,00	<b>10,80</b>

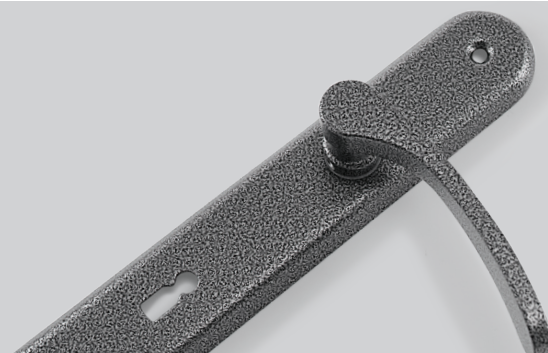



S STRIEBORNÁ

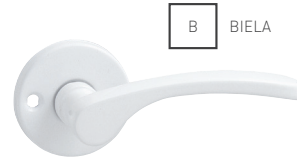



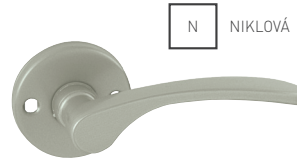

B BIELA

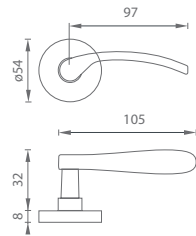

N NIKLOVÁ



## KE - LAURA - R

	Cena za set v €	S, B		N	
		bez DPH	s DPH	bez DPH	s DPH
kl./kl. + rozety BB		6,00	<b>7,20</b>	8,00	<b>9,60</b>
kl./kl. + rozety PZ		6,00	<b>7,20</b>	8,00	<b>9,60</b>
kl./kl. + rozety WC		7,00	<b>8,40</b>	9,00	<b>10,80</b>
guľa/kl. + rozety PZ		7,00	<b>8,40</b>	9,00	<b>10,80</b>





S STRIEBORNÁ

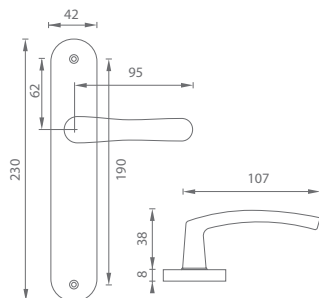

B BIELA



N NIKLOVÁ



Z ZLATÁ







AH ANTIK  
HNEDÁ



H HNEDÁ

## KE - MICHAELA

	Cena za set v €	S, B, Z, AH, H		N	
		bez DPH	s DPH	bez DPH	s DPH
kl./kl. s BB otvorom pre kľúč		6,00	<b>7,20</b>	8,00	<b>9,60</b>
kl./kl. s PZ otvorom pre vložku		6,00	<b>7,20</b>	8,00	<b>9,60</b>
kl./kl. s WC kľúčom		7,00	<b>8,40</b>	9,00	<b>10,80</b>
guľa/kl. s PZ otvorom pre vložku		7,00	<b>8,40</b>	9,00	<b>10,80</b>





Č ČIERNA

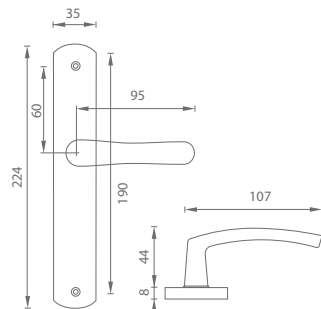

AH ANTI-K HNEĎÁ



AS ANTI-K SIVÁ

## KE - MICHAELA - UOS

	Cena za set v €		bez DPH	s DPH
kl./kl. s PZ otvorom pre vložku			6,00	<b>7,20</b>
madlo/kl. s PZ otvorom pre vložku			14,50	<b>17,40</b>





Č ČIERNA

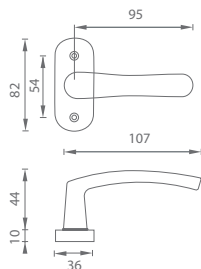

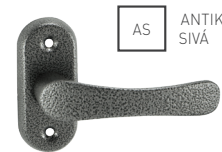

AH ANTIK HNEĎÁ



AS ANTIK SIVÁ



### KE - MICHAELA - UOR

	Cena za set v €	bez DPH	s DPH
kľ./kľ. bez spodnej rozety		5,00	<b>6,00</b>
kľ./kľ. + rozety UOR PZ		6,50	<b>7,80</b>
madlo/kľ. + rozety UOR PZ		11,50	<b>13,80</b>





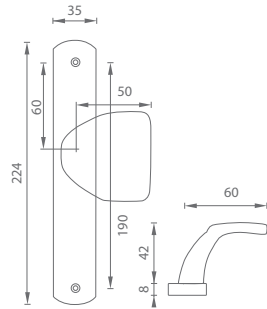

Č ČIERNA



## KE - MADLO PEVNÉ - UOS

Cena za set v € bez DPH s DPH

madlo/madlo s PZ otvorom pre vložku   12,00 **14,40**



72  
90  
ROZTEC



Č ČIERNA

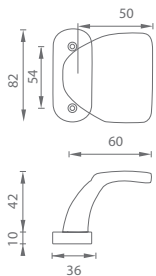
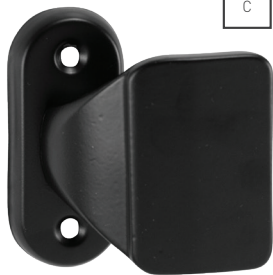

AH ANTIK  
HNEDÁ



AS ANTIK  
SIVÁ



## KE - MADLO PEVNÉ - UOR

	Cena v €	
	bez DPH	s DPH
madlo pevné - kus	5,00	<b>6,00</b>
madlo/madlo bez spodnej rozety	10,00	<b>12,00</b>
madlo/madlo + rozety UOR PZ	12,00	<b>14,40</b>
rozety UOR PZ	2,00	<b>2,40</b>







**S** STRIEBORNÁ

**B** BIELA

**N** NIKLOVÁ







**Z** ZLATÁ

**AH** ANTIK  
HNEDÁ

**H** HNEDÁ

**AS** ANTIK  
SIVÁ

## KE - ROZETY - R

	Cena za set v €	S, B, Z, AH, H, AS		N	
		bez DPH	s DPH	bez DPH	s DPH
rozety BB	 	1,50	<b>1,80</b>	2,00	<b>2,40</b>
rozety PZ	 	1,50	<b>1,80</b>	2,00	<b>2,40</b>
rozety WC	 	3,00	<b>3,60</b>	4,00	<b>4,80</b>



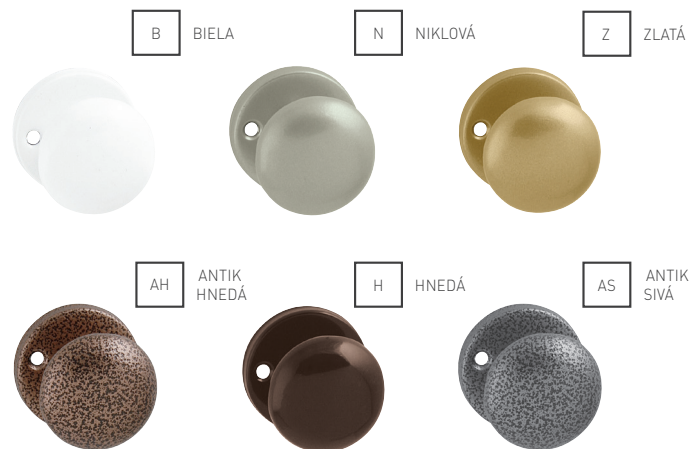
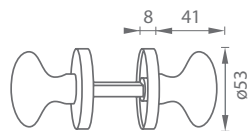

### KE - GUĽA - R

Cena za set v €	S, B, Z, AH, H, AS		N	
	bez DPH	s DPH	bez DPH	s DPH
guľa pevná - kus	3,00	<b>3,60</b>	4,00	<b>4,80</b>
guľa otočná/otočná na rozetách	6,00	<b>7,20</b>	7,50	<b>9,00</b>



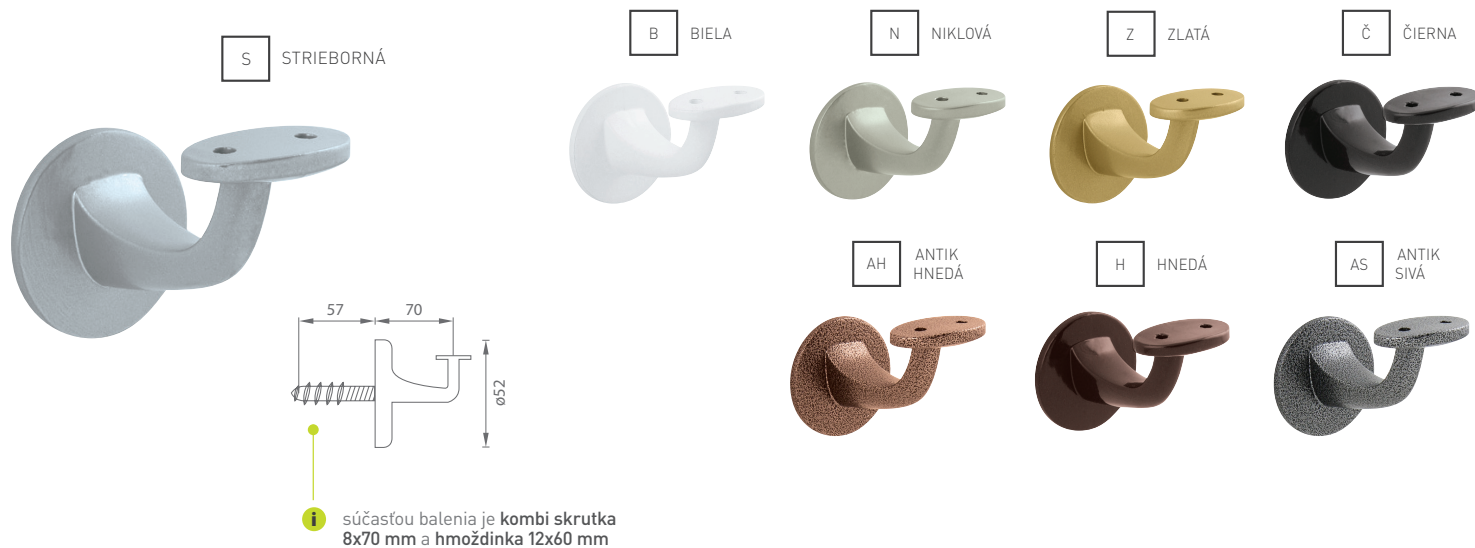

## KE - DRŽIAK MADLA

Cena za set v €	S, B, Z, AH, H, AS		N	
	bez DPH	s DPH	bez DPH	s DPH
držiak schodiskového madla	4,00	<b>4,80</b>	5,50	<b>6,60</b>





S STRIEBORNÁ

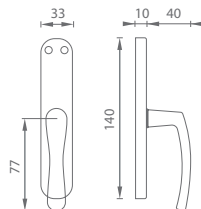

**i** mechanizmus pre rozvoru

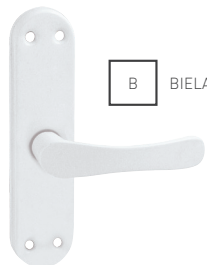

B BIELA



N NIKLOVÁ



Z ZLATÁ



AH ANTIK HNEDÁ



H HNEDÁ

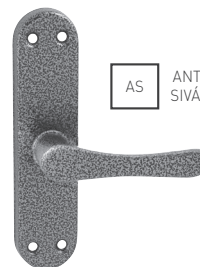

AS ANTIK SIVÁ

### KE - MICHAELA - ROZVORA

Cena za set v €	S, B, Z, AH, H, AS		N	
	bez DPH	s DPH	bez DPH	s DPH
okenná rozvoru	4,50	<b>5,40</b>	6,00	<b>7,20</b>



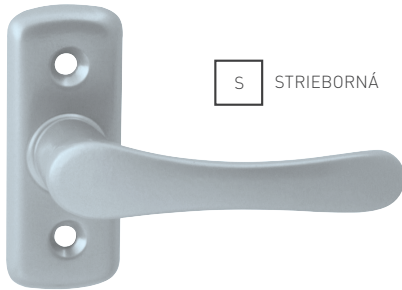

S STRIEBORNÁ

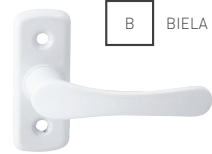

B BIELA

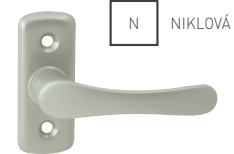

N NIKLOVÁ

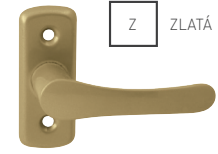

Z ZLATÁ

AH ANTIK  
HNEDÁ

H HNEDÁ

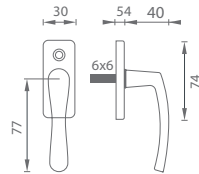
AS ANTIK  
SIVÁ**KE - MICHAELA - POLOLIVA**S, B, Z, AH,  
H, AS

N

Cena za set v €

bez DPH

s DPH

bez DPH

s DPH

okenná pololiva

2,00

**2,40**

2,50

**3,00**





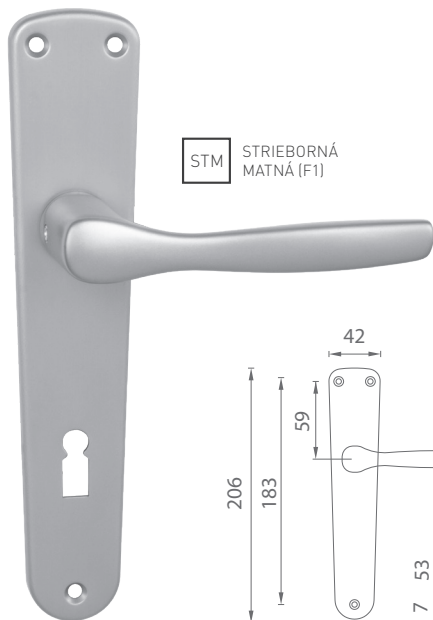

STM STRIEBORNÁ  
MATNÁ (F1)

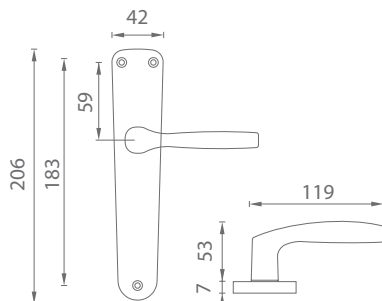



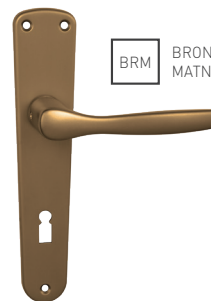

NIM NIKEL  
MATNÝ (F8)



BRM BRONZ  
MATNÝ (F4)

### BA - LUXOR (B)

	Cena za set v €	STM, BRM		NIM	
		bez DPH	s DPH	bez DPH	s DPH
kľ./kľ. bez otvoru		9,60	<b>11,52</b>	10,40	<b>12,48</b>
kľ./kľ. s BB otvorom pre kľúč		9,60	<b>11,52</b>	10,40	<b>12,48</b>
kľ./kľ. s PZ otvorom pre vložku		9,60	<b>11,52</b>	10,40	<b>12,48</b>
kľ./kľ. s WC kľúčom a ukazovateľom		15,10	<b>18,12</b>	-	-
kľ./kľ. s WC kľúčom		-	-	16,40	<b>19,68</b>
guľa/kľ. s PZ otvorom pre vložku		15,80	<b>18,96</b>	17,20	<b>20,64</b>

3  
ROKY ZÁRUKA







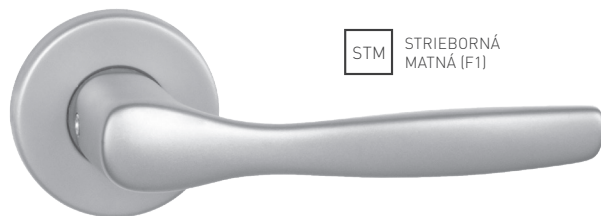
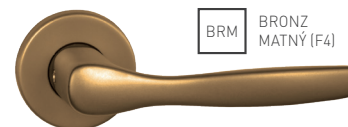
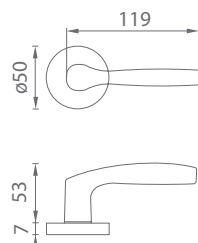





72  
90  
ROZTEC



STM STRIEBORNÁ  
MATNÁ (F1)NIM NIKEL  
MATNÝ (F8)BRM BRONZ  
MATNÝ (F4)

## BA - LUXOR - R

	Cena za set v €	STM, BRM		NIM	
		bez DPH	s DPH	bez DPH	s DPH
kl./kl. bez spodnej rozety		8,30	<b>9,96</b>	8,90	<b>10,68</b>
kl./kl. + rozety BB	 	10,30	<b>12,35</b>	11,10	<b>13,32</b>
kl./kl. + rozety PZ	 	10,30	<b>12,35</b>	11,10	<b>13,32</b>
kl./kl. + rozety WC s ukazovateľom	 	15,30	<b>18,36</b>	16,40	<b>19,68</b>
kl./kl. + rozety WC	 	18,30	<b>21,96</b>	19,90	<b>23,88</b>
guľa/kl. + rozety PZ	 	16,15	<b>19,37</b>	17,65	<b>21,18</b>

3  
ROKY ZÁRUKA

PR



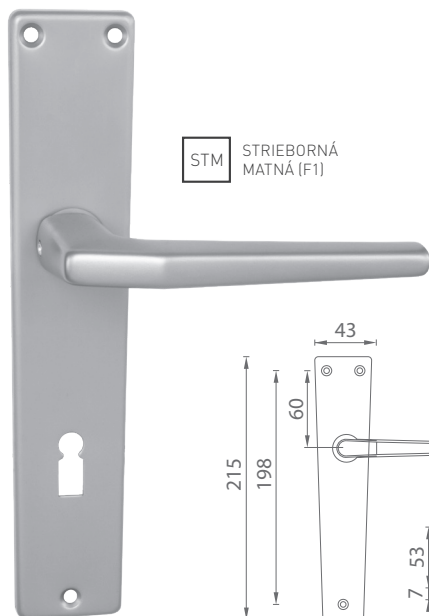

STM STRIEBORNÁ  
MATNÁ (F1)

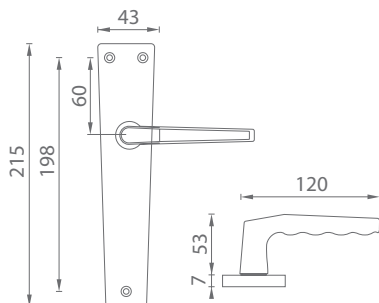





NIM NIKEL  
MATNÝ (F8)



BRM BRONZ  
MATNÝ (F4)

### BA - LUCIA (I)

	Cena za set v €	STM, BRM		NIM	
		bez DPH	s DPH	bez DPH	s DPH
kľ./kľ. bez otvoru		9,80	<b>11,76</b>	10,60	<b>12,72</b>
kľ./kľ. s BB otvorom pre kľúč		9,80	<b>11,76</b>	10,60	<b>12,72</b>
kľ./kľ. s PZ otvorom pre vložku		9,80	<b>11,76</b>	10,60	<b>12,72</b>
kľ./kľ. s WC kľúčom a ukazovateľom		15,30	<b>18,36</b>	-	-
kľ./kľ. s WC kľúčom		-	-	16,60	<b>19,92</b>
guľa/kľ. s PZ otvorom pre vložku		15,90	<b>19,08</b>	17,30	<b>20,76</b>







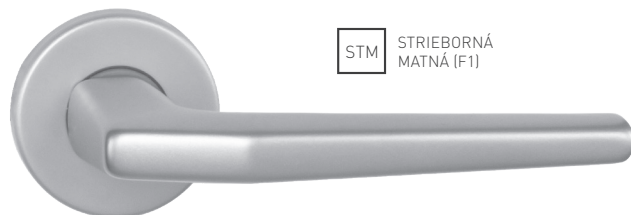
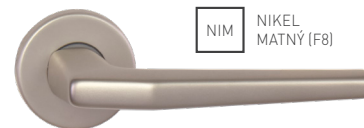
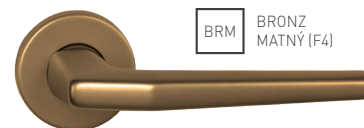
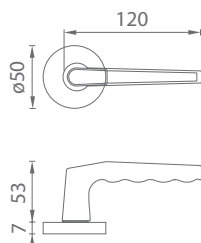



3  
ROKY ZÁRUKA



72  
90  
ROZTEC

STM STRIEBORNÁ  
MATNÁ (F1)NIM NIKEL  
MATNÝ (F8)BRM BRONZ  
MATNÝ (F4)

## BA - LUCIA - R

	Cena za set v €	STM, BRM		NIM	
		bez DPH	s DPH	bez DPH	s DPH
kl./kl. bez spodnej rozety		8,50	<b>10,20</b>	9,10	<b>10,92</b>
kl./kl. + rozety BB	 	10,50	<b>12,59</b>	11,30	<b>13,56</b>
kl./kl. + rozety PZ	 	10,50	<b>12,59</b>	11,30	<b>13,56</b>
kl./kl. + rozety WC s ukazovateľom	 	15,50	<b>18,60</b>	16,60	<b>19,92</b>
kl./kl. + rozety WC	 	18,50	<b>22,20</b>	20,10	<b>24,12</b>
guľa/kl. + rozety PZ	 	16,25	<b>19,49</b>	17,75	<b>21,30</b>







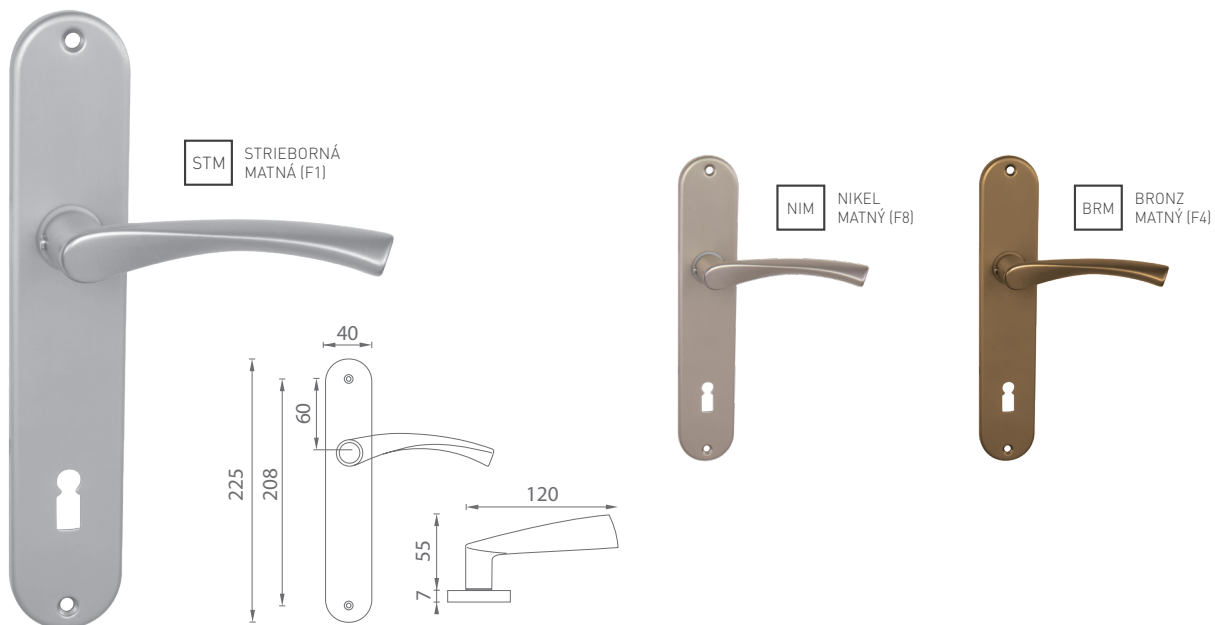



3  
ROKY ZÁRUKA

PR





### BA - TORNADO (S)

	Cena za set v €	STM, BRM		NIM	
		bez DPH	s DPH	bez DPH	s DPH
kľ./kľ. bez otvoru		12,50	<b>15,00</b>	13,50	<b>16,20</b>
kľ./kľ. s BB otvorom pre kľúč	 	12,50	<b>15,00</b>	13,50	<b>16,20</b>
kľ./kľ. s PZ otvorom pre vložku	 	12,50	<b>15,00</b>	13,50	<b>16,20</b>
kľ./kľ. s WC kľúčom a ukazovateľom	 	17,90	<b>21,48</b>	-	-
kľ./kľ. s WC kľúčom	 	-	-	19,50	<b>23,40</b>
guľa/kľ. s PZ otvorom pre vložku	 	17,75	<b>21,30</b>	19,25	<b>23,10</b>







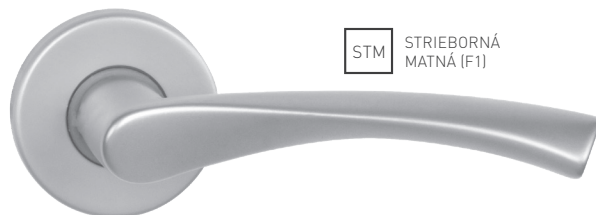
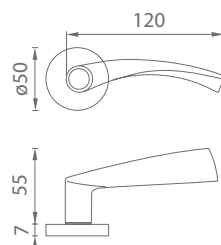



3  
ROKY ZÁRUKA



72  
90  
ROZTEC

STM STRIEBORNÁ  
MATNÁ (F1)NIM NIKEL  
MATNÝ (F8)BRM BRONZ  
MATNÝ (F4)

## BA - TORNADO - R

	Cena za set v €	STM, BRM		NIM	
		bez DPH	s DPH	bez DPH	s DPH
kl./kl. bez spodnej rozety		11,00	<b>13,20</b>	11,80	<b>14,16</b>
kl./kl. + rozety BB	 	13,00	<b>15,59</b>	14,00	<b>16,80</b>
kl./kl. + rozety PZ	 	13,00	<b>15,59</b>	14,00	<b>16,80</b>
kl./kl. + rozety WC s ukazovateľom	 	18,00	<b>21,60</b>	19,30	<b>23,16</b>
kl./kl. + rozety WC	 	21,00	<b>25,20</b>	22,80	<b>27,36</b>
guľa/kl. + rozety PZ	 	17,50	<b>20,99</b>	19,10	<b>22,92</b>







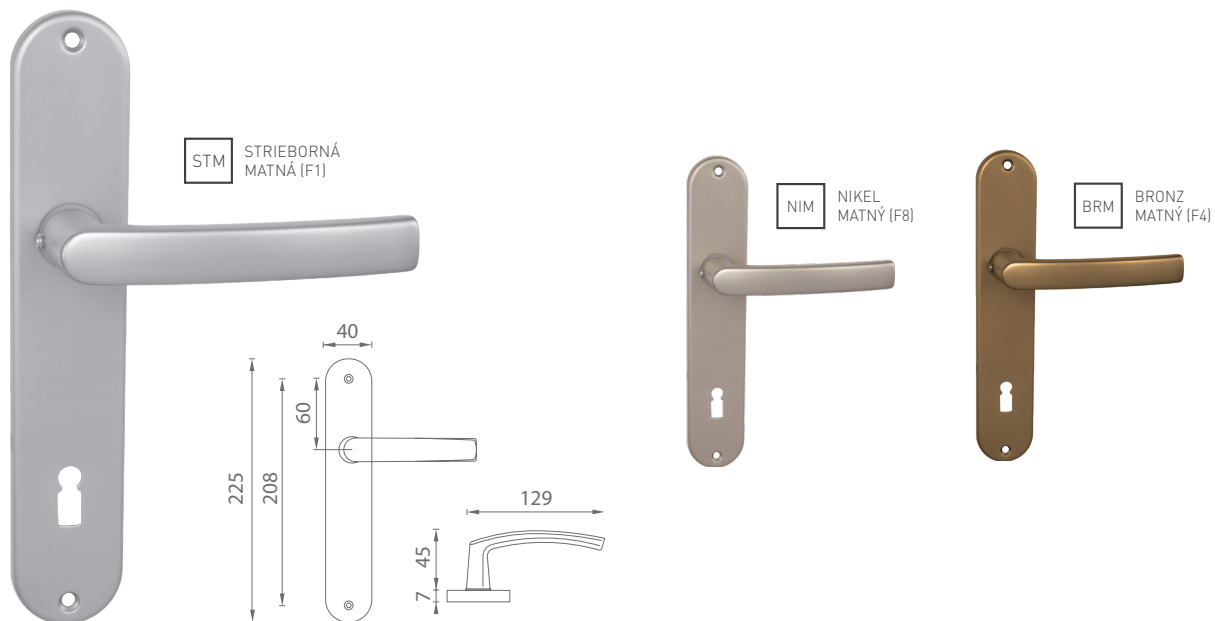



3  
ROKY ZÁRUKA

PR





### BA - MIRA (S)

	Cena za set v €	STM, BRM		NIM	
		bez DPH	s DPH	bez DPH	s DPH
kľ./kľ. bez otvoru		10,50	<b>12,60</b>	11,30	<b>13,56</b>
kľ./kľ. s BB otvorom pre kľúč	 	10,50	<b>12,60</b>	11,30	<b>13,56</b>
kľ./kľ. s PZ otvorom pre vložku	 	10,50	<b>12,60</b>	11,30	<b>13,56</b>
kľ./kľ. s WC kľúčom a ukazovateľom	 	15,90	<b>19,08</b>	-	-
kľ./kľ. s WC kľúčom	 	-	-	17,30	<b>20,76</b>
guľa/kľ. s PZ otvorom pre vložku	 	16,75	<b>20,10</b>	18,15	<b>21,78</b>

**3**  
ROKY ZÁRUKA



**72**  
**90**  
ROZTEC

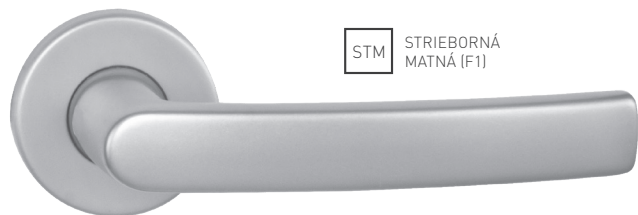

STM STRIEBORNÁ  
MATNÁ (F1)



NIM NIKEL  
MATNÝ (F8)

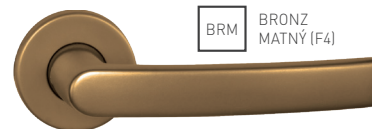

BRM BRONZ  
MATNÝ (F4)

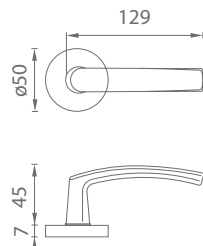

## BA - MIRA - R

	Cena za set v €	STM, BRM		NIM	
		bez DPH	s DPH	bez DPH	s DPH
kl./kl. bez spodnej rozety		9,00	<b>10,80</b>	9,60	<b>11,52</b>
kl./kl. + rozety BB		11,00	<b>13,19</b>	11,80	<b>14,16</b>
kl./kl. + rozety PZ		11,00	<b>13,19</b>	11,80	<b>14,16</b>
kl./kl. + rozety WC s ukazovateľom		16,00	<b>19,20</b>	17,10	<b>20,52</b>
kl./kl. + rozety WC		19,00	<b>22,80</b>	20,60	<b>24,72</b>
guľa/kl. + rozety PZ		16,50	<b>19,79</b>	18,00	<b>21,60</b>

3  
ROKY ZÁRUKA





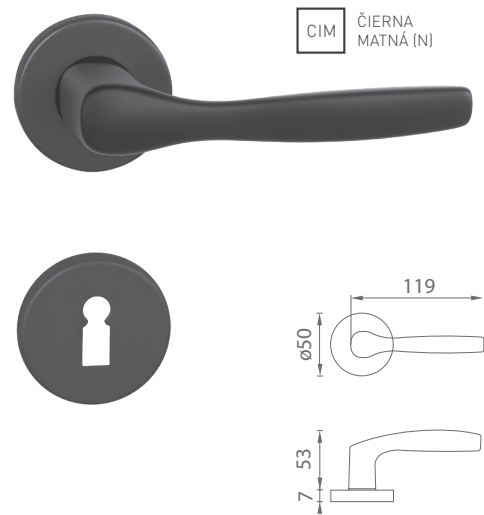
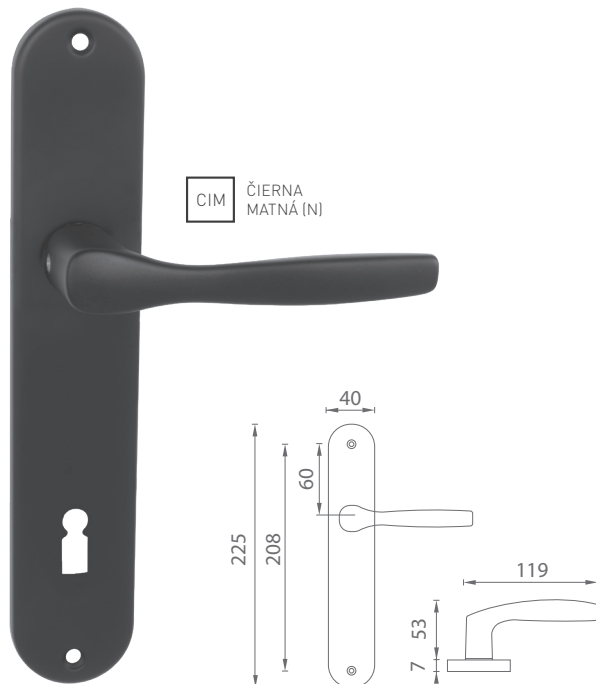

PR





### BA - LUXOR (S)





		Cena za set v €	bez DPH	s DPH
kl./kl. bez otvoru		14,40	<b>17,28</b>	
kl./kl. s BB otvorom pre kľúč		14,40	<b>17,28</b>	
kl./kl. s PZ otvorom pre vložku		14,40	<b>17,28</b>	
kl./kl. s WC kľúčom		21,90	<b>26,28</b>	
guľa/kl. s PZ otvorom pre vložku		20,70	<b>24,84</b>	

**3**  
ROKY ZÁRUKA



**72**  
**90**  
ROZETEC

### BA - LUXOR - R

		Cena za set v €	bez DPH	s DPH
kl./kl. bez spodnej rozety		12,00	<b>14,40</b>	
kl./kl. + rozety BB		15,50	<b>18,60</b>	
kl./kl. + rozety PZ		15,50	<b>18,60</b>	
kl./kl. + rozety WC s ukazovateľom		22,50	<b>27,00</b>	
kl./kl. + rozety WC		26,00	<b>31,20</b>	
guľa/kl. + rozety PZ		21,00	<b>25,20</b>	

**3**  
ROKY ZÁRUKA



**PR**







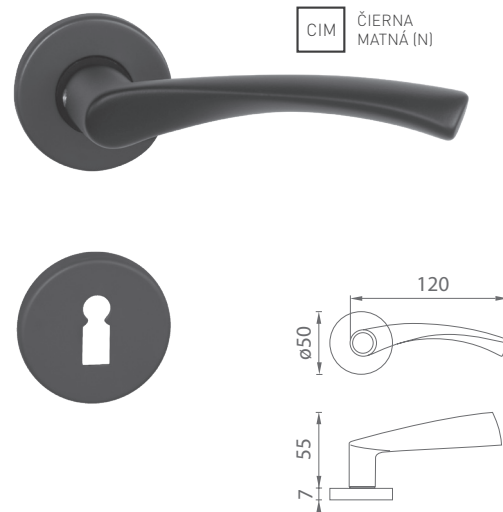









### BA - TORNADO (S)

		Cena za set v €	bez DPH	s DPH
kľ./kľ. bez otvoru		16,70	<b>20,04</b>	
kľ./kľ. s BB otvorom pre kľúč		16,70	<b>20,04</b>	
kľ./kľ. s PZ otvorom pre vložku		16,70	<b>20,04</b>	
kľ./kľ. s WC kľúčom		24,20	<b>29,04</b>	
guľa/kľ. s PZ otvorom pre vložku		21,85	<b>26,22</b>	



### BA - TORNADO - R

		Cena za set v €	bez DPH	s DPH
kľ./kľ. bez spodnej rozety		14,30	<b>17,16</b>	
kľ./kľ. + rozety BB		17,80	<b>21,36</b>	
kľ./kľ. + rozety PZ		17,80	<b>21,36</b>	
kľ./kľ. + rozety WC s ukazovateľom		24,80	<b>29,76</b>	
kľ./kľ. + rozety WC		28,30	<b>33,96</b>	
guľa/kľ. + rozety PZ		22,15	<b>26,58</b>	



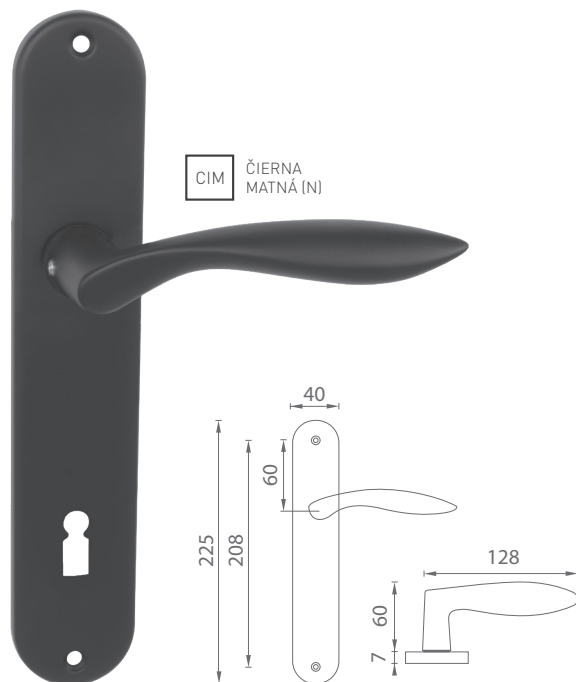



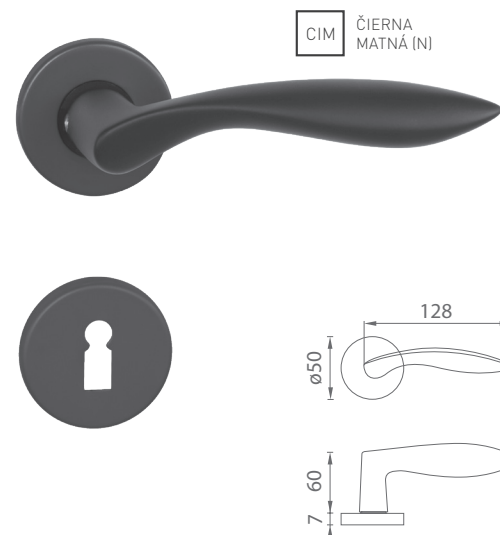

CIM ČIERNÁ  
MATNÁ (N)



CIM ČIERNÁ  
MATNÁ (N)

## BA - CLAUDIA (S)





		Cena za set v €	bez DPH	s DPH
kľ./kľ. bez otvoru		17,90	<b>21,48</b>	
kľ./kľ. s BB otvorom pre kľúč		17,90	<b>21,48</b>	
kľ./kľ. s PZ otvorom pre vložku		17,90	<b>21,48</b>	
kľ./kľ. s WC kľúčom		25,40	<b>30,48</b>	
guľa/kľ. s PZ otvorom pre vložku		22,45	<b>26,94</b>	

**3**  
ROKY ZÁRUKA



**72**  
**90**  
ROZTEC

## BA - CLAUDIA - R

		Cena za set v €	bez DPH	s DPH
kľ./kľ. bez spodnej rozety		15,50	<b>18,60</b>	
kľ./kľ. + rozety BB		19,00	<b>22,80</b>	
kľ./kľ. + rozety PZ		19,00	<b>22,80</b>	
kľ./kľ. + rozety WC s ukazovateľom		26,00	<b>31,20</b>	
kľ./kľ. + rozety WC		29,50	<b>35,40</b>	
guľa/kľ. + rozety PZ		22,75	<b>27,30</b>	

**3**  
ROKY ZÁRUKA





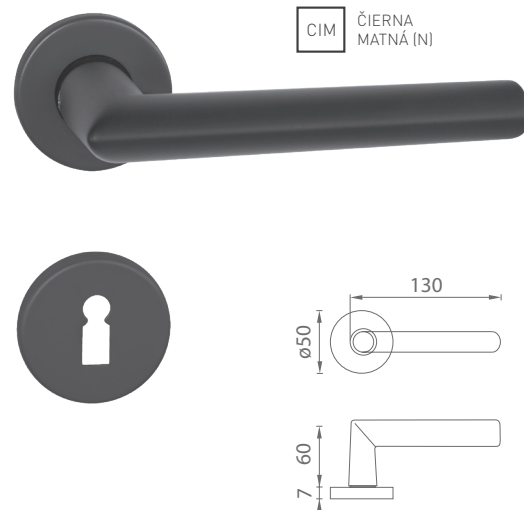
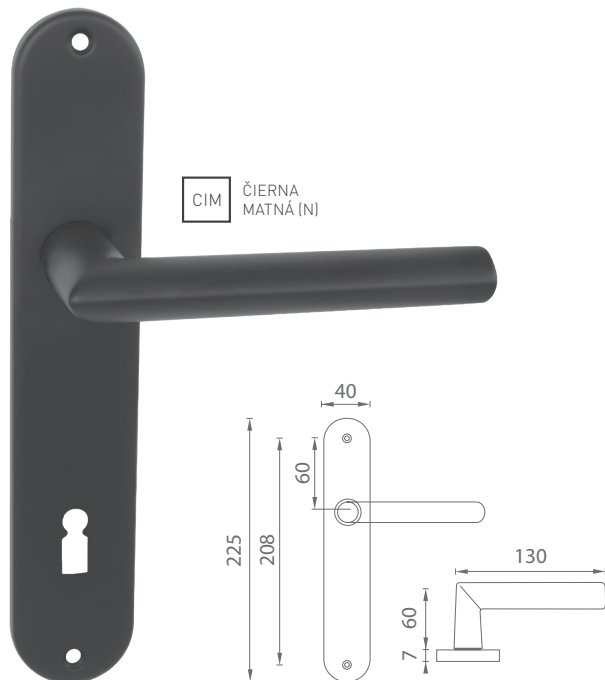

**PR**









### BA - NEVADA (S)

		Cena za set v €	bez DPH	s DPH
kľ./kľ. bez otvoru		15,90	<b>19,08</b>	
kľ./kľ. s BB otvorom pre kľúč		15,90	<b>19,08</b>	
kľ./kľ. s PZ otvorom pre vložku		15,90	<b>19,08</b>	
kľ./kľ. s WC kľúčom		23,40	<b>28,08</b>	
guľa/kľ. s PZ otvorom pre vložku		21,45	<b>25,74</b>	



### BA - NEVADA - R

		Cena za set v €	bez DPH	s DPH
kľ./kľ. bez spodnej rozety		13,50	<b>16,20</b>	
kľ./kľ. + rozety BB		17,00	<b>20,40</b>	
kľ./kľ. + rozety PZ		17,00	<b>20,40</b>	
kľ./kľ. + rozety WC s ukazovateľom		24,00	<b>28,80</b>	
kľ./kľ. + rozety WC		27,50	<b>33,00</b>	
guľa/kľ. + rozety PZ		21,75	<b>26,10</b>	



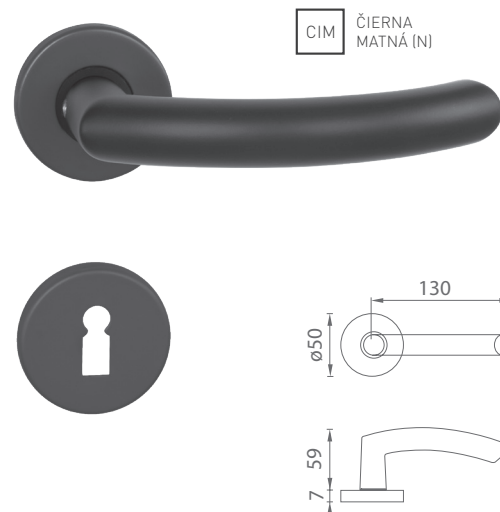
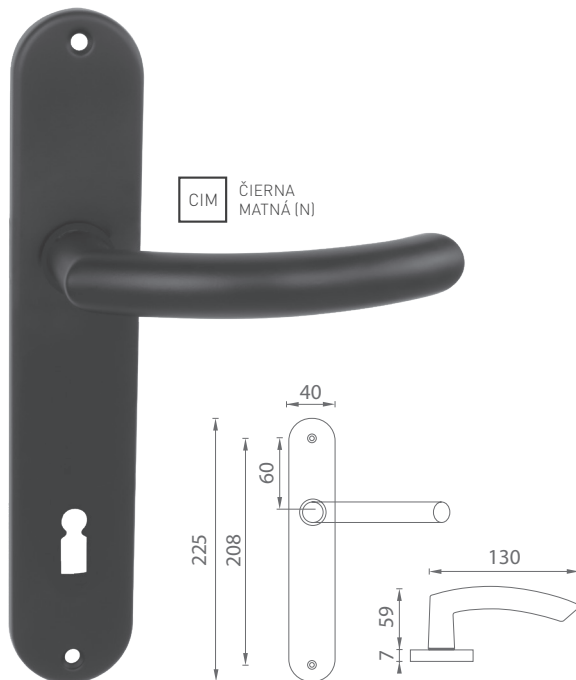

## BA - NERO (S)

		Cena za set v €	bez DPH	s DPH
kľ./kľ. bez otvoru		15,90	<b>19,08</b>	
kľ./kľ. s BB otvorom pre kľúč		15,90	<b>19,08</b>	
kľ./kľ. s PZ otvorom pre vložku		15,90	<b>19,08</b>	
kľ./kľ. s WC kľúčom		23,40	<b>28,08</b>	
guľa/kľ. s PZ otvorom pre vložku		21,45	<b>25,74</b>	

**3**  
ROKY ZÁRUKA



**72**  
**90**  
ROZTEC

## BA - NERO - R

		Cena za set v €	bez DPH	s DPH
kľ./kľ. bez spodnej rozety		13,50	<b>16,20</b>	
kľ./kľ. + rozety BB		17,00	<b>20,40</b>	
kľ./kľ. + rozety PZ		17,00	<b>20,40</b>	
kľ./kľ. + rozety WC s ukazovateľom		24,00	<b>28,80</b>	
kľ./kľ. + rozety WC		27,50	<b>33,00</b>	
guľa/kľ. + rozety PZ		21,75	<b>26,10</b>	

**3**  
ROKY ZÁRUKA



**PR**



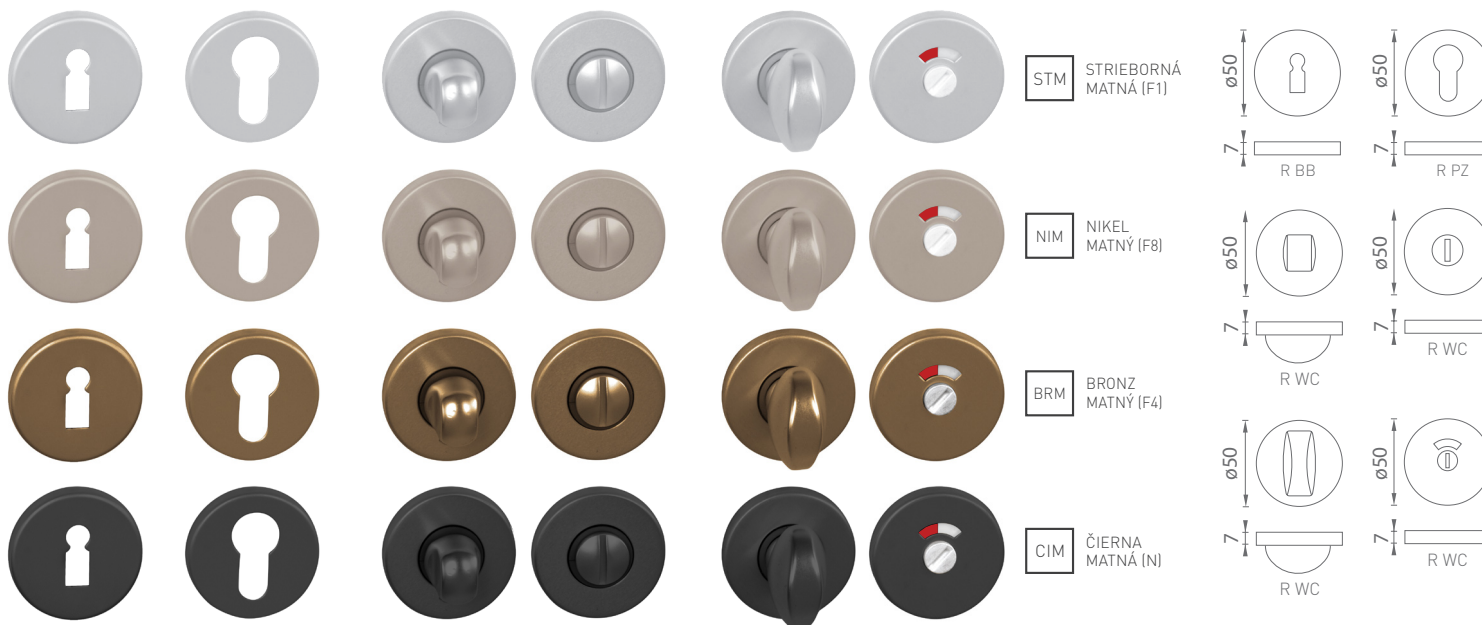

### BA - ROZETY - R

	Cena za set v €	STM, BRM		NIM		CIM	
		bez DPH	s DPH	bez DPH	s DPH	bez DPH	s DPH
rozety BB		2,00	<b>2,39</b>	2,20	<b>2,64</b>	<b>3,50</b>	<b>4,20</b>
rozety PZ		2,00	<b>2,39</b>	2,20	<b>2,64</b>	<b>3,50</b>	<b>4,20</b>
rozety WC		10,00	<b>12,00</b>	11,00	<b>13,20</b>	<b>14,00</b>	<b>16,80</b>
rozety WC s ukazovateľom		7,00	<b>8,40</b>	7,50	<b>9,00</b>	<b>10,50</b>	<b>12,60</b>





## BA - HLINÍKOVÉ MADIELKO 3815

	BIM, CIM		STM, BRM		NIM	
	bez DPH	s DPH	bez DPH	s DPH	bez DPH	s DPH
hliníkové madielko	5,50	<b>6,60</b>	3,00	<b>3,60</b>	<b>3,50</b>	<b>4,20</b>





STM STRIEBORNÁ  
MATNÁ (F1)

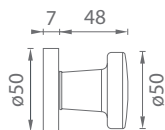

NIM NIKEL  
MATNÝ (F8)



BRM BRONZ  
MATNÝ (F4)



CIM ČIERNA  
MATNÁ (N)

### BA - GUĽA PEVNÁ NA ROZETE

	STM, BRM		NIM		CIM	
	bez DPH	s DPH	bez DPH	s DPH	bez DPH	s DPH
guľa pevná na rozete	10,00	<b>12,00</b>	11,00	<b>13,20</b>	11,50	<b>13,80</b>

3  
ROKY ZÁRUKA







STM STRIEBORNÁ  
MATNÁ (F1)

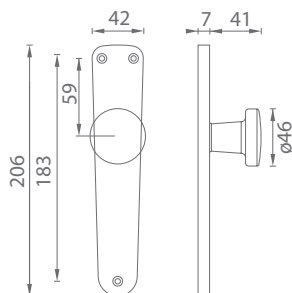

NIM NIKEL  
MATNÝ (F8)

BRM BRONZ  
MATNÝ (F4)



**i** Používaná pri modeloch LUXOR v povrchoch STM, NIM, BRM

## BA - GUĽA NA ŠTÍTE (B)

	STM, BRM		NIM		
	Cena za kus v €	bez DPH	s DPH	bez DPH	s DPH
guľa pevná na štíte bez otvoru		11,00	<b>13,20</b>	12,00	<b>14,40</b>
guľa pevná na štíte s PZ otvorom		11,00	<b>13,20</b>	12,00	<b>14,40</b>

**3**  
ROKY ZÁRUKA



**72**  
**90**  
ROZTEC



STM STRIEBORNÁ  
MATNÁ (F1)

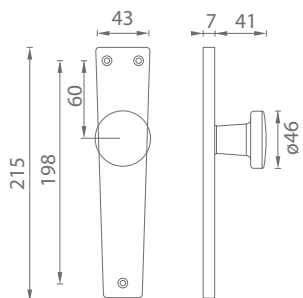

NIM NIKEL  
MATNÝ (F8)

BRM BRONZ  
MATNÝ (F4)



**i** Používaná pri modeloch LUCIA v povrchoch STM, NIM, BRM

### BA - GUĽA NA ŠTÍTE (I)

	Cena za kus v €	STM, BRM		NIM	
		bez DPH	s DPH	bez DPH	s DPH
guľa pevná na štíte bez otvoru		11,00	<b>13,20</b>	12,00	<b>14,40</b>
guľa pevná na štíte s PZ otvorom 		11,00	<b>13,20</b>	12,00	<b>14,40</b>

**3**  
ROKY ZÁRUKA



**72**  
**90**  
ROZTEC



STM STRIEBORNÁ  
MATNÁ (F1)

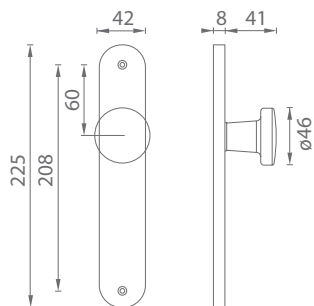

NIM NIKEL  
MATNÝ (F8)



BRM BRONZ  
MATNÝ (F4)



CIM ČIERNÁ  
MATNÁ (N)



**i** Používaná pri modeloch TORNADO, CLAUDIA, NEVADA, NERO v povrchoch STM, NIM, BRM, CIM a LUXOR CIM

## BA - GUĽA NA ŠTÍTE (S)

	STM, BRM		NIM		CIM		
	Cena za kus v €	bez DPH	s DPH	bez DPH	s DPH	bez DPH	s DPH
guľa pevná na štíte bez otvoru		11,50	<b>13,80</b>	12,50	<b>15,00</b>	<b>13,50</b>	<b>16,20</b>
guľa pevná na štíte s PZ otvorom		11,50	<b>13,80</b>	12,50	<b>15,00</b>	<b>13,50</b>	<b>16,20</b>

**3**  
ROKY ZÁRUKA



**72**  
**90**  
ROZTEC

STM STRIEBORNÁ  
MATNÁ (F1)



BIM BIELA  
MATNÁ (B)



NIM NIKEL  
MATNÝ (F8)



BRM BRONZ  
MATNÝ (F4)



CIM ČIERNA  
MATNÁ (N)

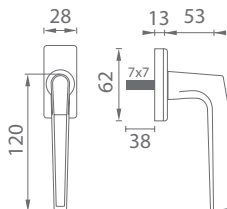

## BA - LUCIA EUROOKNO

	BIM, CIM		STM, BRM		NIM	
	bez DPH	s DPH	bez DPH	s DPH	bez DPH	s DPH
kľučka na eurookno	7,50	<b>9,00</b>	5,10	<b>6,12</b>	<b>6,00</b>	<b>7,20</b>



STM STRIEBORNÁ  
MATNÁ (F1)



BIM BIELA MATNÁ (B)    NIM NIKEL MATNÝ (F8)    BRM BRONZ MATNÝ (F4)    CIM ČIERNA MATNÁ (N)

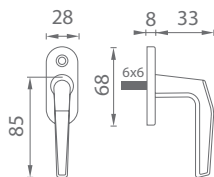
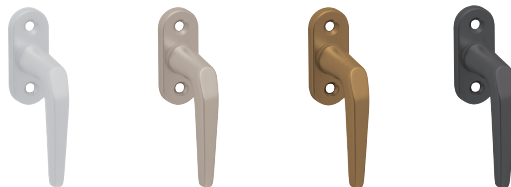

## BA - LUCIA POLOLIVA

	BIM, CIM		STM, BRM		NIM	
	bez DPH	s DPH	bez DPH	s DPH	bez DPH	s DPH
okenná pololiva	6,50	<b>7,80</b>	4,00	<b>4,80</b>	<b>4,50</b>	<b>5,40</b>





STM STRIEBORNÁ  
MATNÁ (F1)

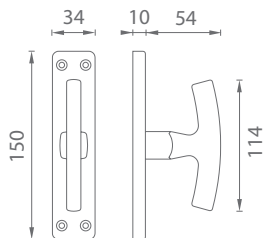

BIM BIELA  
MATNÁ (B)



NIM NIKEL  
MATNÝ (F8)



BRM BRONZ  
MATNÝ (F4)



CIM ČIERNA  
MATNÁ (N)



## BA - LUCIA OLIVA

	BIM, CIM		STM, BRM		NIM	
	bez DPH	s DPH	bez DPH	s DPH	bez DPH	s DPH
okenná oliva	8,50	<b>10,20</b>	6,50	<b>7,80</b>	<b>7,00</b>	<b>8,40</b>





**STM** STRIEBORNÁ  
MATNÁ (F1)

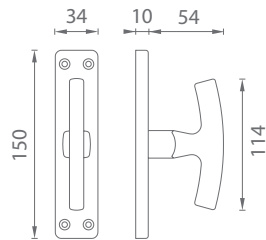

**BIM** BIELA  
MATNÁ (B)



**NIM** NIKEL  
MATNÝ (F8)



**BRM** BRONZ  
MATNÝ (F4)



**CIM** ČIERNA  
MATNÁ (N)



**i** mechanizmus  
pre rozvoru



## BA - LUCIA ROZVORA

	BIM, CIM		STM, BRM		NIM	
	bez DPH	s DPH	bez DPH	s DPH	bez DPH	s DPH
okenná rozvora	12,10	<b>14,52</b>	10,10	<b>12,12</b>	<b>10,60</b>	<b>12,72</b>





**i** Štandardná rozteč kovania je **92 mm**.  
 Alternatívnu rozteč **90 mm** získame  
 otočením štvorhranu 6 x 8 mm o 90°.  
 Štvorhran 6 x 8 mm je súčasťou balenia.

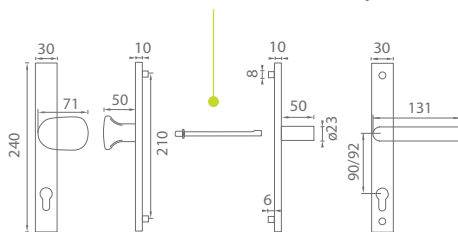

### WA - FELIX H1

			Cena za set v €	bez DPH	s DPH
kľ./kľ. s PZ otvorom (90 mm)			42,50		<b>51,00</b>
kľ./kľ. s PZ otvorom (92 mm)			42,50		<b>51,00</b>
madlo/kľ. s PZ otvorom (90 mm)			42,50		<b>51,00</b>
madlo/kľ. s PZ otvorom (92 mm)			42,50		<b>51,00</b>
ma./ma. otočné s PZ otvorom (90 mm)			42,50		<b>51,00</b>
ma./ma. otočné s PZ otvorom (92 mm)			42,50		<b>51,00</b>







**S** STRIEBORNÁ  
RAL 9006



**B** BIELA  
RAL 9016



**Z** ZLATÁ  
RAL 1036W



**H** HNEDÁ  
RAL 8017

**i** Štandardná rozteč kovania je **92 mm**.  
Alternatívnu rozteč **90 mm** získame  
otočením štvorhranu 6 x 8 mm o 90°.  
Štvorhran 6 x 8 mm je súčasťou balenia.

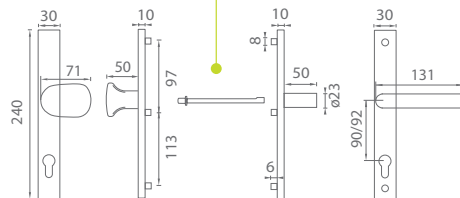













**HS** HNEDOSIVÁ  
RAL 8019



**Č** ČIERNA  
RAL 9005

## WA - FELIX H2

		Cena za set v €	bez DPH	s DPH
kl./kl. s PZ otvorom (90 mm)	 	23,50	<b>28,20</b>	
kl./kl. s PZ otvorom (92 mm)	 	23,50	<b>28,20</b>	
madlo/kl. s PZ otvorom (90 mm)	 	23,50	<b>28,20</b>	
madlo/kl. s PZ otvorom (92 mm)	 	23,50	<b>28,20</b>	
ma./ma. otočné s PZ otvorom (90 mm)	 	23,50	<b>28,20</b>	
ma./ma. otočné s PZ otvorom (92 mm)	 	23,50	<b>28,20</b>	

**5**  
ROKOV ZÁRUKA



**90**  
**92**  
ROZTEČ









CP CHRÓM PERLA



NP NIKEL PERLA



### WA - FELIX - UHR - CP, NP



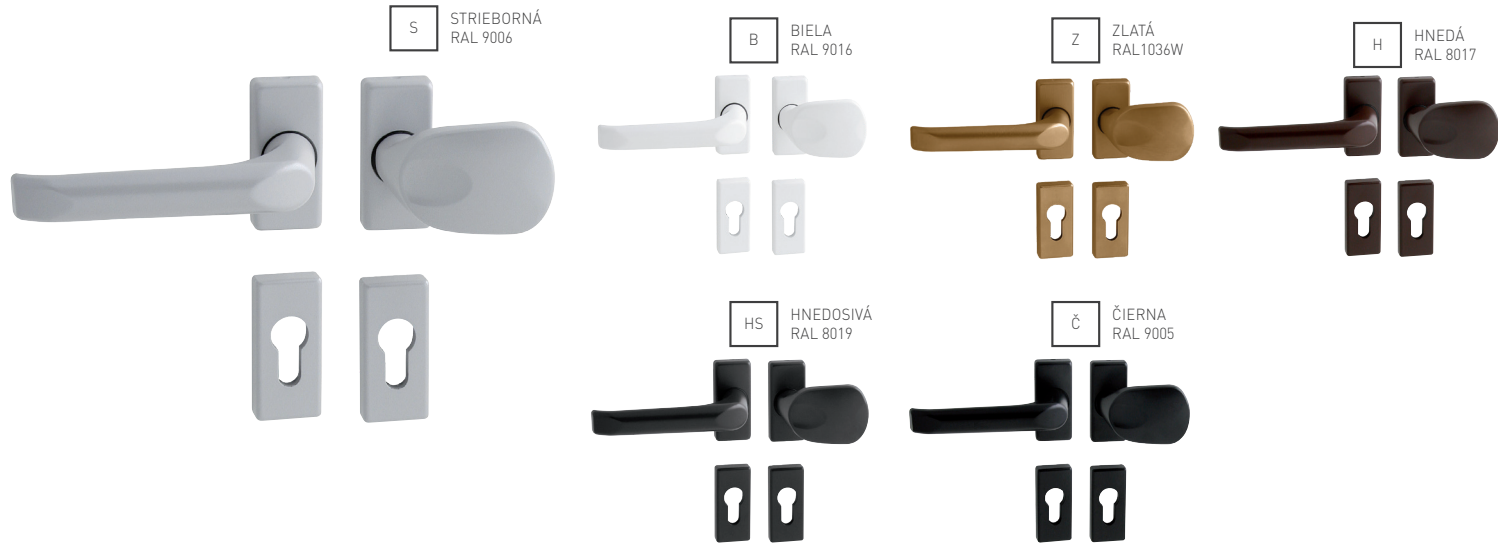

		Cena za set v €	bez DPH	s DPH
kl./kl. bez spodnej rozety		41,50		<b>49,80</b>
kl./kl. + rozety PZ	 	55,50		<b>66,60</b>
madlo/kl. bez spodnej rozety		41,50		<b>49,80</b>
madlo/kl. + rozety PZ	 	55,50		<b>66,60</b>

5  
ROKOV ZÁRUKA





## WA - FELIX - UHR

		Cena za set v €	bez DPH	s DPH
kl./kl. bez spodnej rozety		22,50	<b>27,00</b>	
kl./kl. + rozety PZ	 	30,00	<b>36,00</b>	
madlo/kl. bez spodnej rozety		22,50	<b>27,00</b>	
madlo/kl. + rozety PZ	 	30,00	<b>36,00</b>	

**3**  
ROZET ZABŔA



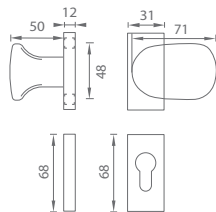







### WA - MADLO FELIX - UHR - CP, NP

	Cena v €	bez DPH	s DPH
madlo pevné alebo otočné - kus	21,00		<b>25,20</b>
madlo pevné/pevné - pár	43,00		<b>51,60</b>
madlo otočné/otočné - pár	43,00		<b>51,60</b>
madlo pevné/otočné - pár	43,00		<b>51,60</b>



### WA - MADLO FELIX - UHR - CP, NP

	Cena za set v €	bez DPH	s DPH
madlo pevné/pevné + UHR PZ	 	57,00	<b>68,40</b>
madlo otočné/otočné + UHR PZ	 	57,00	<b>68,40</b>
madlo pevné/otočné + UHR PZ	 	57,00	<b>68,40</b>



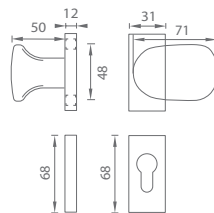

## WA - MADLO FELIX - UHR

	Cena v €	bez DPH	s DPH
madlo pevné alebo otočné - kus	11,50	<b>13,80</b>	
madlo pevné/pevné - pár	24,00	<b>28,80</b>	
madlo otočné/otočné - pár	24,00	<b>28,80</b>	
madlo pevné/otočné - pár	24,00	<b>28,80</b>	

**3**  
ROKY ZÁRUKA



## WA - MADLO FELIX - UHR

	Cena v €	bez DPH	s DPH
madlo pevné/pevné + UHR PZ	31,50	<b>37,80</b>	
madlo otočné/otočné + UHR PZ	31,50	<b>37,80</b>	
madlo pevné/otočné + UHR PZ	31,50	<b>37,80</b>	

**3**  
ROKY ZÁRUKA



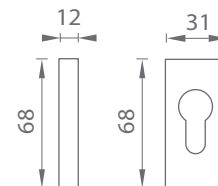

- |    |                |    |                |   |                        |   |                   |   |                   |   |                   |    |                       |   |                    |
|----|----------------|----|----------------|---|------------------------|---|-------------------|---|-------------------|---|-------------------|----|-----------------------|---|--------------------|
| CP | CHRÓM<br>PERLA | NP | NIKEL<br>PERLA | S | STRIEBORNÁ<br>RAL 9006 | B | BIELA<br>RAL 9016 | Z | ZLATÁ<br>RAL1036W | H | HNEDÁ<br>RAL 8017 | HS | HNEDOSIVÁ<br>RAL 8019 | Č | ČIERNA<br>RAL 9005 |
|----|----------------|----|----------------|---|------------------------|---|-------------------|---|-------------------|---|-------------------|----|-----------------------|---|--------------------|

### WA - ROZETY - UHR PZ - CP, NP

		Cena za pár v €	bez DPH	s DPH
rozety UHR PZ - CP, NP		14,00	<b>16,80</b>	



### WA - ROZETY - UHR PZ

		Cena za pár v €	bez DPH	s DPH
rozety UHR PZ		7,50	<b>9,00</b>	



**MP KOVANIA®**

SME S VAMI OD ROKU 2002

**MP KOVANIA®**

KOVANIA NA DVERE, STAVBY A NÁBYTOK

MP KOVANIA s.r.o. | Nová Rožňavská 1  
831 04 Bratislava  
+421 2 444 555 85  
mp@mp-kovania.sk

[www.mp-kovania.sk](http://www.mp-kovania.sk)  
[www.mp-kovania.sk/katalogy](http://www.mp-kovania.sk/katalogy)